

Park Benches with Backs, 6' & 4, "Buddy Bench" or Standard Bench

In-Ground or Portable/Surface Mount with Perforated Steel Planks

- Specifications -

Rev.: 01Apr'15

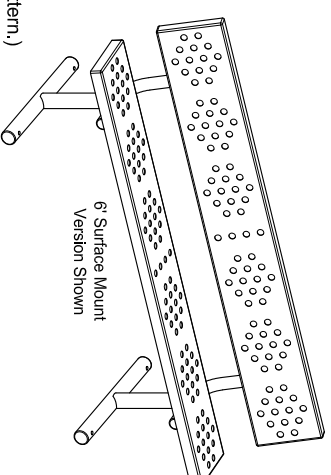

In-Ground Leg Style

Portable/Surface Mount Leg Style

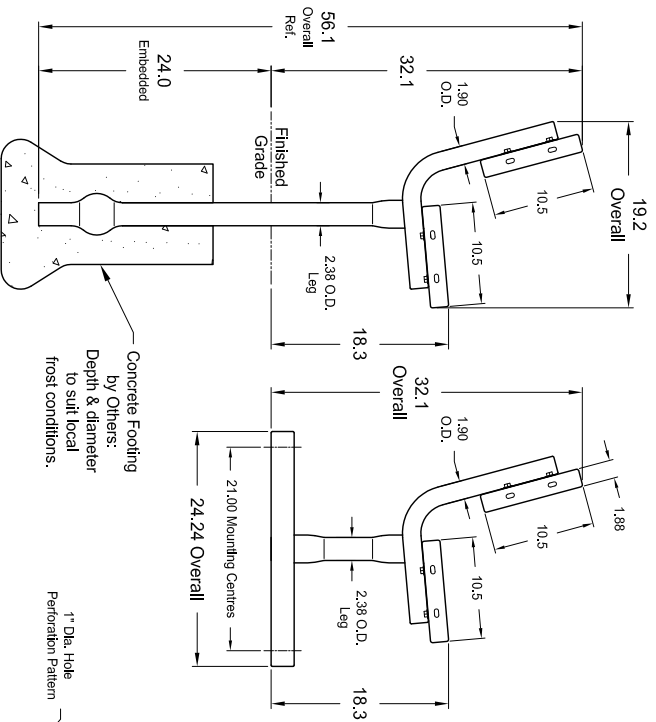

"Buddy Bench" Models: (Seat Plank has Standard 1" Round Hole Perforation Pattern.)

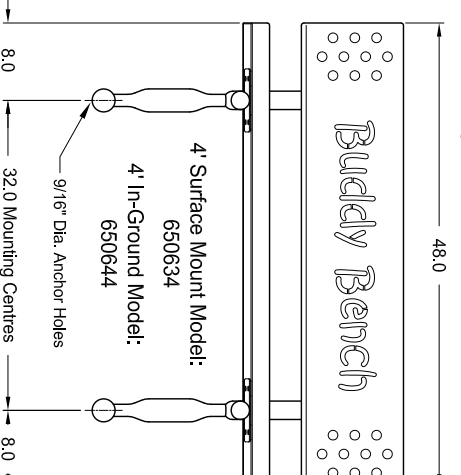
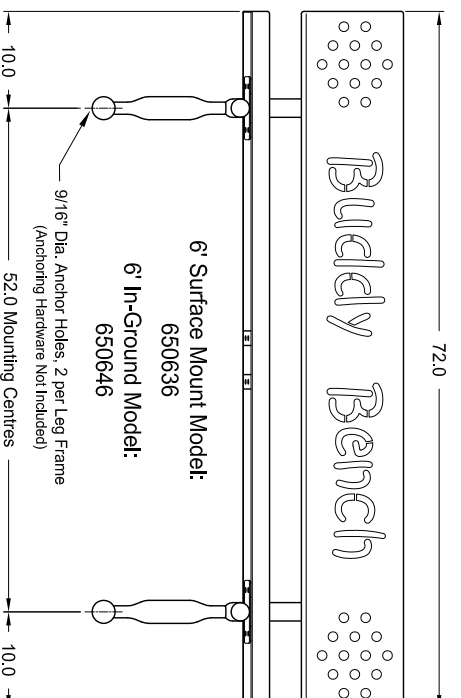

Standard 1" Round Hole Perforation Pattern Models:

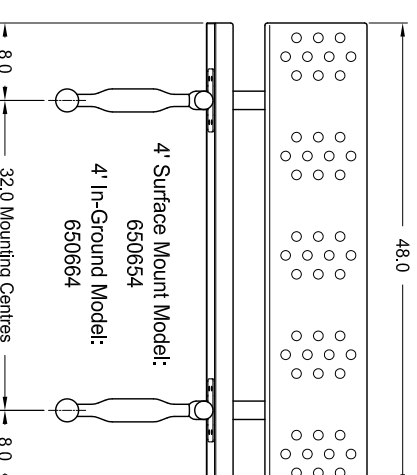
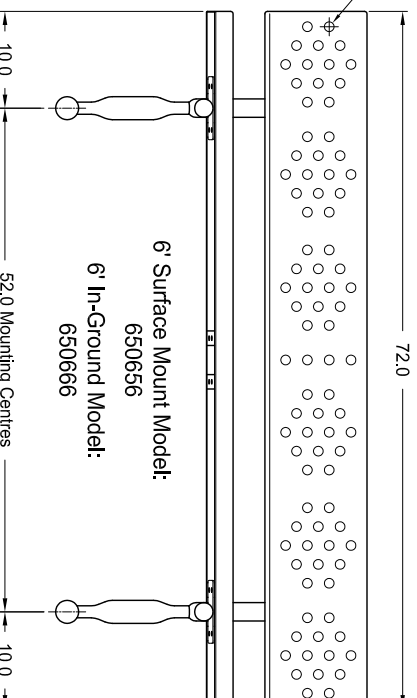

Typical Assembly Method

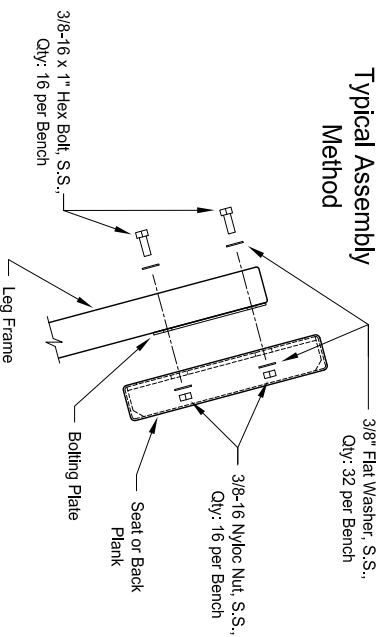

Materials:

- 2.375" O.D. x .125" Wall HSS Tube (Leg Tubes)
- 1.9" O.D. x .125" Wall HSS Tube (Seat Tubes)
- 11 Ga. Steel (Bolting Plates)
- 13 Ga. Perforated Steel (Seat & Backrest Planks)
- 7 Ga. Steel (Seat Brackets/Ribs)
- Stainless Steel Hardware
- Anchoring Hardware Not Included

Seat Plank Finish:

- Polyester Powder Paint over Zinc Rich Primer.

Leg Frame Finishes:

- 1) Polyester Powder Paint over Zinc Rich Primer.
- 2) Hot Dip Galvanized

Notes:

- Dimensions shown are in inches.
- Knill Fabrication Ltd. maintains a policy of continuous product improvement. As a result, some details may change without notice.